

***TECHNICAL MANUAL***  
***Of***  
***Intel GM45 Express Chipset***  
***&***  
***ICH9M Chipset***  
***Based***  
***Mini-ITX M/B for Penryn Processor***

***NO.G03-NF3-F***

***Rev 1.0***

**Release date: Feb., 2009**

**Trademark:**

\* Specifications and Information contained in this documentation are furnished for information use only, and are subject to change at any time without notice, and should not be construed as a commitment by manufacturer.

---

---

## Environmental Protection Announcement

Do not dispose this electronic device into the trash while discarding. To minimize pollution and ensure environment protection of mother earth, please recycle.



---

---

# TABLE OF CONTENT

USER'S NOTICE .....	iii
MANUAL REVISION INFORMATION .....	iii
ITEM CHECKLIST .....	iii
<b>CHAPTER 1 INTRODUCTION OF INTELCHIPSET MOTHERBOARD</b>	
1-1 FEATURE OF MOTHERBOARD .....	1
1-2 SPECIFICATION .....	2
1-3 LAYOUT DIAGRAM & JUMPER SETTING .....	3
<b>CHAPTER 2 HARDWARE INSTALLATION</b>	
2-1 JUMPER SETTING .....	7
2-2 CONNECTORS AND HEADERS .....	10
2-2-1 CONNECTORS .....	10
2-2-2 HEADERS .....	11
<b>CHAPTER 3</b>	
3-1 ENTERING SETUP .....	19
3-2 GETTING HELP .....	19
3-3 THE MAIN MENU .....	19
3-4 ADVANCED BIOS FEATURES .....	22
3-4-1 CPU FEATURE .....	25
3-5 INTERGRATED PERIPHERALS .....	25
3-5-1 INTEL DTS FEATURE .....	26
3-6 PC HEALTH STATUS .....	28
3-7 ADVANCED CHIPSET FEATURES .....	29
3-8 POWER MANAGEMENT SETTING .....	30
3-9 PnP/PCI CONFIGURATION .....	32



## Safety Environmental Instruction

---

- Avoid the dusty, humidity and temperature extremes. Do not place the product in any area where it may become wet.
- 0 to 60 centigrade is the suitable temperature. (The figure comes from the request of the main chipset)
- Generally speaking, dramatic changes in temperature may lead to contact malfunction and crackles due to constant thermal expansion and contraction from the welding spots' that connect components and PCB. Computer should go through an adaptive phase before it boots when it is moved from a cold environment to a warmer one to avoid condensation phenomenon. These water drops attached on PCB or the surface of the components can bring about phenomena as minor as computer instability resulted from corrosion and oxidation from components and PCB or as major as short circuit that can burn the components. Suggest starting the computer until the temperature goes up.
- The increasing temperature of the capacitor may decrease the life of computer. Using the close case may decrease the life of other device because the higher temperature in the inner of the case.
- Attention to the heat sink when you over-clocking. The higher temperature may decrease the life of the device and burned the capacitor.

---

---

## USER'S NOTICE

COPYRIGHT OF THIS MANUAL BELONGS TO THE MANUFACTURER. NO PART OF THIS MANUAL, INCLUDING THE PRODUCTS AND SOFTWARE DESCRIBED IN IT MAY BE REPRODUCED, TRANSMITTED OR TRANSLATED INTO ANY LANGUAGE IN ANY FORM OR BY ANY MEANS WITHOUT WRITTEN PERMISSION OF THE MANUFACTURER.

THIS MANUAL CONTAINS ALL INFORMATION REQUIRED TO USE **INTEL GM45 CHIPSET** MOTHER-BOARD SERIES AND WE DO ASSURE THIS MANUAL MEETS USER'S REQUIREMENT BUT WILL CHANGE, CORRECT ANY TIME WITHOUT NOTICE. MANUFACTURER PROVIDES THIS MANUAL "AS IS" WITHOUT WARRANTY OF ANY KIND, AND WILL NOT BE LIABLE FOR ANY INDIRECT, SPECIAL, INCIDENTAL OR CONSEQUENTIAL DAMAGES (INCLUDING DAMAGES FOR LOSS OF PROFIT, LOSS OF BUSINESS, LOSS OF USE OF DATA, INTERRUPTION OF BUSINESS AND THE LIKE).

PRODUCTS AND CORPORATE NAMES APPEARING IN THIS MANUAL MAY OR MAY NOT BE REGISTERED TRADEMARKS OR COPYRIGHTS OF THEIR RESPECTIVE COMPANIES, AND THEY ARE USED ONLY FOR IDENTIFICATION OR EXPLANATION AND TO THE OWNER'S BENEFIT, WITHOUT INTENT TO INFRINGE.

## Manual Revision Information

Reversion	Revision History	Date
1.0	First Edition	February, 2009

## Item Checklist

- Motherboard
- Cable(s)
- CD for motherboard utilities
- Motherboard User's Manual
- Back panel

---

---

# Chapter 1

## Introduction of the Motherboard

### 1-1 Feature of motherboard

- Intel GM45+ICH9M chipset.
- Penryn CPU, with low power consumption never denies high performance.
- Support FSB 1066MHz
- Support two DDRII SODIMM 800/667MHz up to 4 GB.
- Onboard two REALTEK RTL 8111C Gigabit Ethernet LAN.
- Integrated ALC888 6-channel HD audio CODEC.
- Support USB2.0 data transport demands.
- Support RS422/485 and watchdog.
- Support GPIO function.

---

---

## 1-2 Specification

<b>Spec</b>	<b>Description</b>
<b>Design</b>	* Mini ITX form factor 8 layers PCB size: 17.0x17.0cm
<b>Chipset</b>	* Intel GM45+ICH9M Chipset
<b>CPU</b>	* Penryn CPU
<b>Memory Socket</b>	* 200-pin DDRII SO-DIMM socket x2 * Support DDRII SODIMM 800/667 MHz system Modules DDRII SODIMM memory * Expandable to 4GB.
<b>Expansion Slots</b>	* 32-bit PCI slot x 1pcs * Mini PCI-E x1pcs
<b>Integrate IDE</b>	* One PCI IDE controller that supports PCI Bus Mastering, ATA PIO/DMA and the ULTRA DMA 100/66 functions that deliver the data transfer rate up to 100 MB/s.
<b>LAN</b>	* Integrated two Realtek RTL8111C PCI-E Gigabit LAN. * Support Fast Ethernet LAN function of providing 10Mb/100Mb/1000Mb Ethernet data transfer rate
<b>Audio</b>	* ALC888 6 channel Audio Codec integrated * Audio driver and utility included
<b>BIOS</b>	* Award 8MB Flash DIP ROM
<b>Multi I/O</b>	* Hard disk drive connector x1 * SATAII x4 * USB2.0 port x 4 and headers x6 * RJ45 LAN connector x2 * Audio connector x1 (Line-in, Line-out, MIC, <b>SPDIF_OUT</b> ) * COM connector x 2 * COM Header x2

	<ul style="list-style-type: none"> <li>* LVDS Connector x1</li> <li>* VGA Connector x1</li> <li>* DVI-D Connector x1</li> <li>* TV OUT x1</li> <li>* HDMI Connector x1</li> </ul>
--	---

### 1-3 Layout Diagram & Jumper Setting

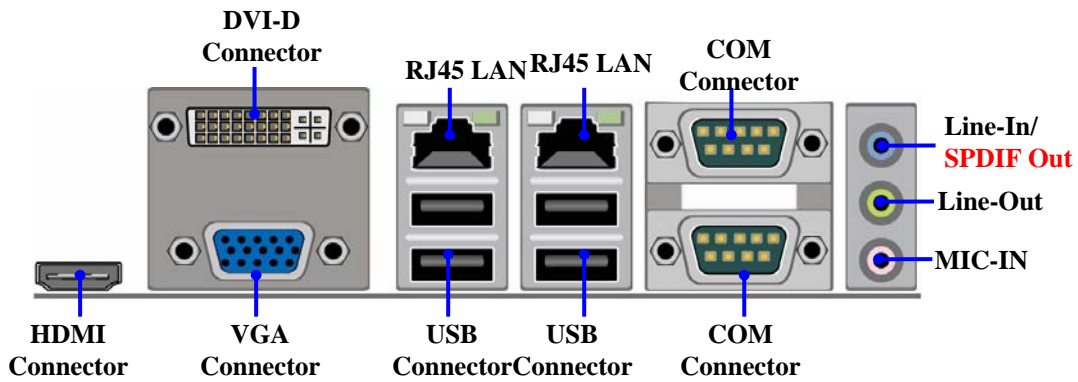



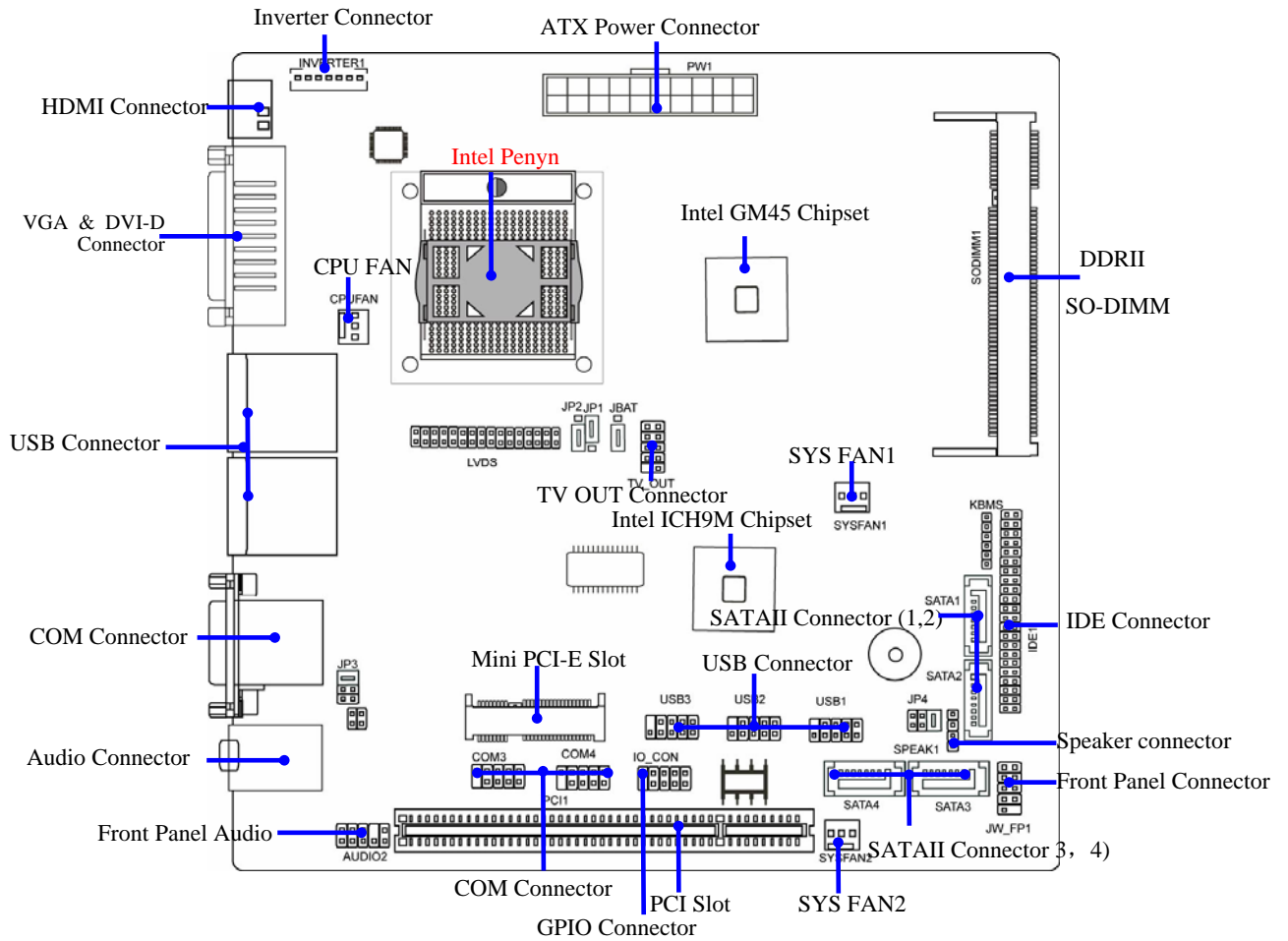

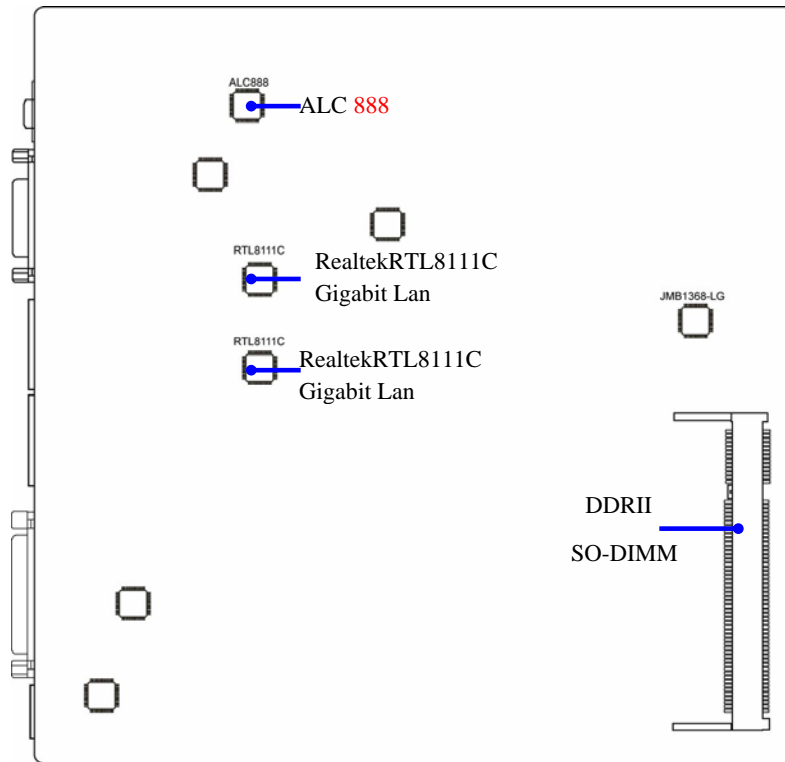

---

---

## *Jumper*

<b>Jumper</b>	<b>Name</b>	<b>Description</b>	<b>Page</b>
JP1	Panel backlight selecting	3-pin Block	P.8
JBAT	CMOS RAM Clear Function Setting	3-pin Block	P.8
JP2	Panel VDD Select	3-pin Block	P.9
JP3	RS232/422/485 Function Select	6-pin Block	P.9
JP4	<b>Powered RS232 Select</b>	6-pin Block	P.10

## *Connectors*

<b>Connector</b>	<b>Name</b>	<b>Description</b>	<b>Page</b>
USB	USB Port Connector	4-pin Connector	P.10
UL2	RJ45 LAN Connector	RJ-45 Connector	P.10
VGA	Video Graphic Attach Connector	D-sub15-pin Female	P.10
AUDIO1	Line-Out /MIC/Line-In Audio Connector	3 Phone Jack	P.10
COM1,2	Serial Port COM1 Connector	9-pin Connector	P.10
DVI-D Connector	DVI port connector	24-pin Connector	P.10
HDMI Connector	HDMI port connector	<b>19-pin Connector</b>	P.10

---

---

## *Headers*

<b>Header</b>	<b>Name</b>	<b>Description</b>	<b>Page</b>
CPUFAN,SYSFAN1/2	FAN Speed Headers	3-pin Block	P.15
AUDIO1	Front panel audio Headers	9-pin block	P.11
TV Out1	TV Out Header	9-pin block	P.14
PWR LED	Power LED	4-pin Block	P.15
LVDS	LVDS Connector	32-pin Block	P.12
Inverter	LVDS Inverter Connector	7-pin Block	P.13
COM3,4	Serial Port COM3/4 Connector	9-pin Connector	P.16
JW_FP (PWR LED/ HD LED/ /Power Button /Reset)	Front Panel Header (PWR LED/ HD LED/ /Power Button /Reset)	9-pin Block	P.15
SATA1~4	Serial ATAII IDE Connector	7-pin Connector	P.11
GPIO	GPIO header	10-pin Connector	P.16
KBMS Header	PS/2 Keyboard and mouse connector	6-pin Connector	P.17

---

---

# Chapter 2

## 2-1 Jumper Setting

### (1) Clear CMOS (3-pin): JBAT

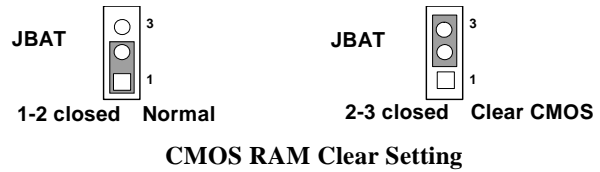
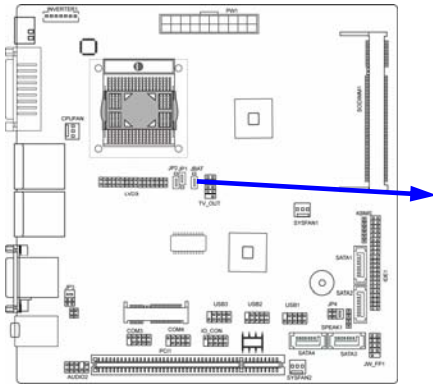

### (2) JP1: Panel backlights select (3-pin)

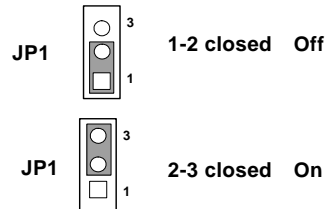
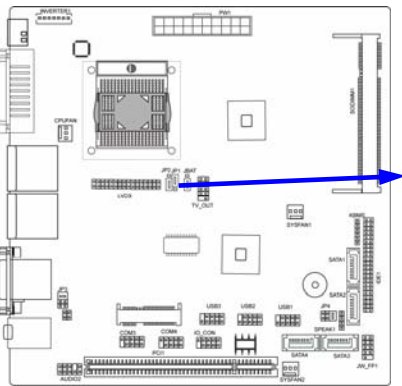

---

---

**(3) JP2: Panel VDD Select (3-pin)**

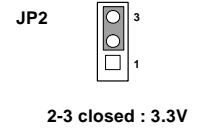
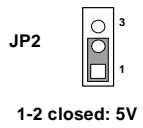
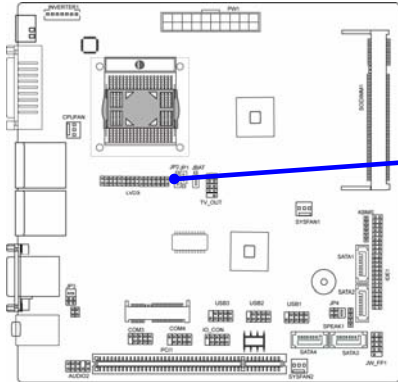

**(4) JP3: Power RS232/422/485 Function Select**

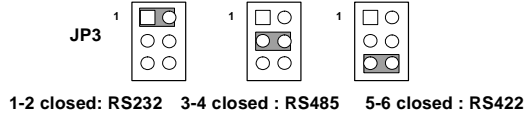
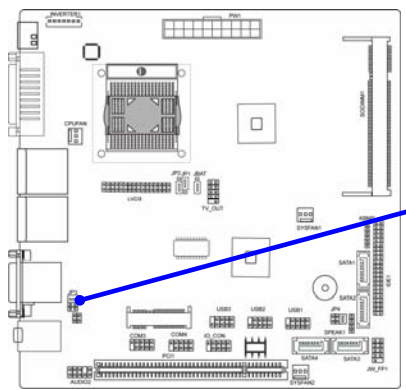

(5) JP4: Powered RS232 Select :

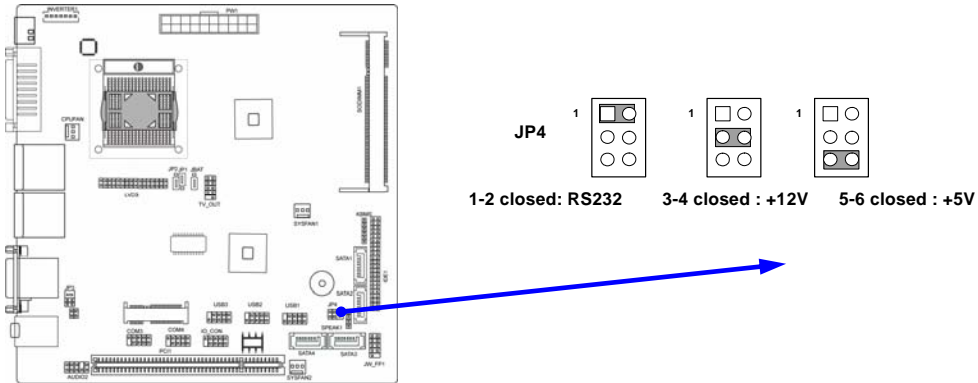

## 2-2 Connectors and Headers

### 2-2-1 Connectors

(1) Audio Connector: (Line-In/ Line-Out/ MIC-In)

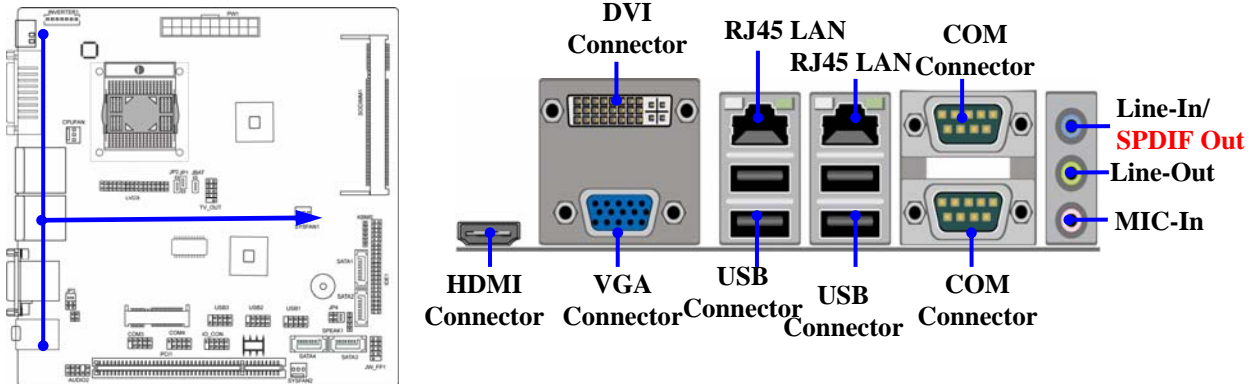

---

---

## (2) Serial-ATA Port connector: SATA1/SATA2/ SATA3/SATA4

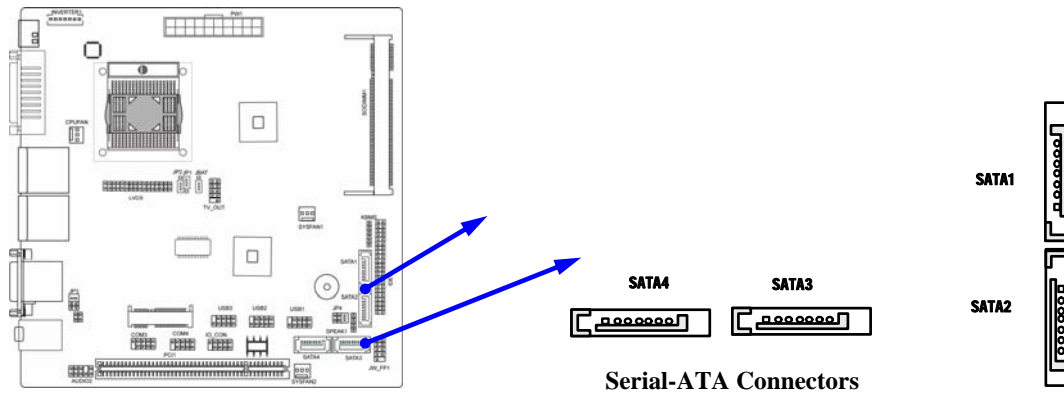

## 2-2-2 Headers

### (1) Front panel audio (9-pin): AUDIO1

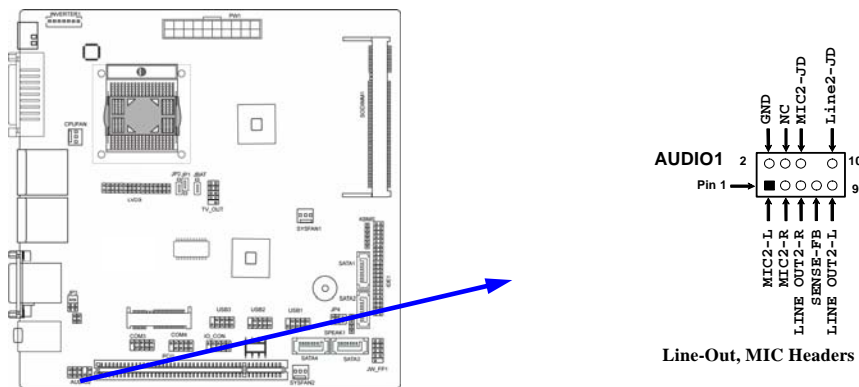



---

---

**(2) LVDS Headers: LVDS**

Pin NO.	Pin Define	Pin NO.	Pin Define
Pin 1	NC	Pin 2	NC
Pin 3	LVDS_CLKBN	Pin 4	LVDS_CLKBP
Pin 5	LVDSA_DATAN2	Pin 6	LVDSA_DATAP2
Pin 7	LVDSA_DATAN1	Pin 8	LVDSA_DATAP1
Pin 9	LVDSA_DATAN0	Pin 10	LVDSA_DATAP0
Pin 11	LVDS_DDC_DATA	Pin 12	LVDS_DDC_CLK
Pin 13	GND	Pin 14	GND
Pin 15	GND	Pin 16	GND
Pin 17	NC	Pin 18	NC
Pin 19	LVDS_CLKAP	Pin 20	LVDS_CLKAN
Pin 21	LVDSB_DATAP2	Pin 22	LVDSB_DATAN2
Pin 23	LVDSB_DATAP1	Pin 24	LVDSB_DATAN1
Pin 25	LVDSB_DATAP0	Pin 26	LVDSB_DATAN0
Pin 27	PVDD	Pin 28	PVDD
Pin 29	PVDD	Pin 30	PVDD
Pin 31	GND	Pin 32	GND

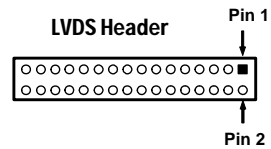
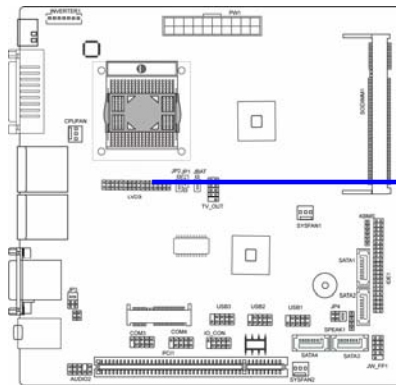

**(3) Pin-headers of LVDS Inverter:**

Pin 1 and pin2: VCC of inverter

Pin3 、 pin4 and pin6: GND

Pin5: Backlight

Pin7: Brightness

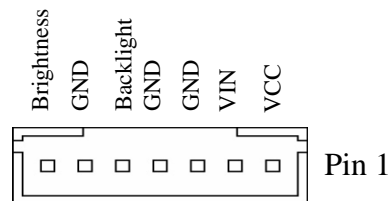
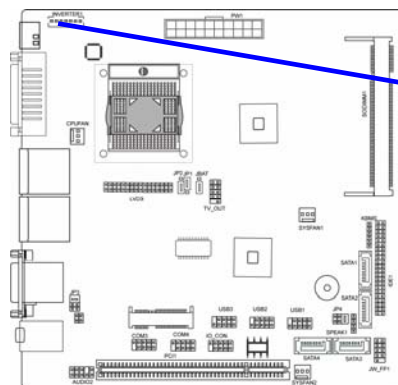

**(4) TV-OUT Header:**

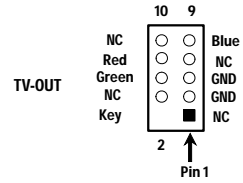
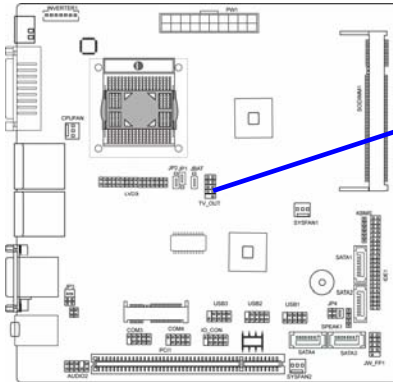

**TV-OUT Header**

**(6) RS422/485 Header:**

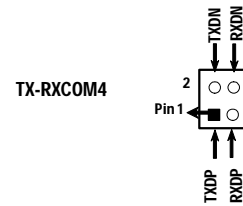
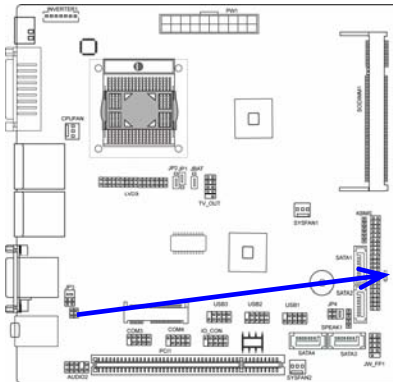

**RS422/485 Header**

---

---

**(7) JW-FP (9-pin)**

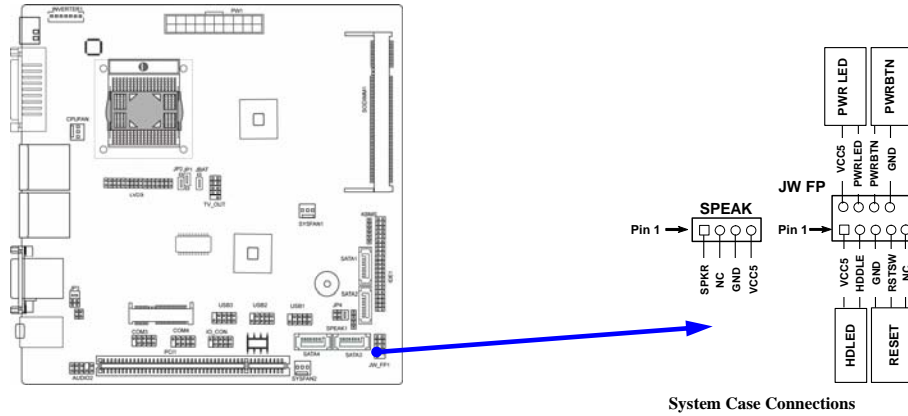

**(8) FAN Speed Headers (3-pin): CPUFAN, SFAN1/SFAN2**

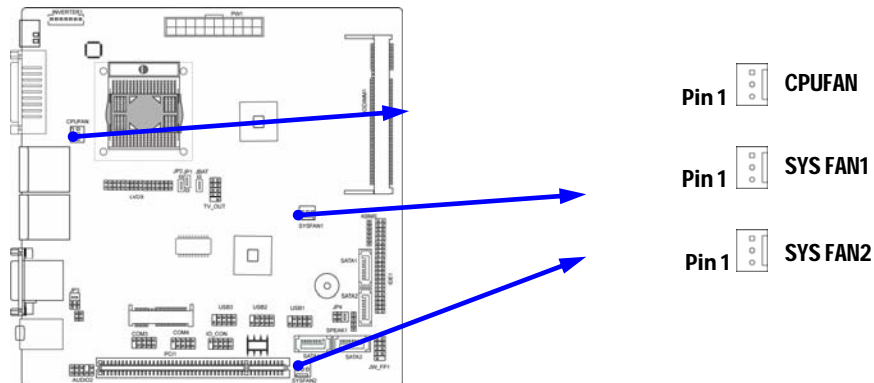

**(9) COM Header (9-pin):**

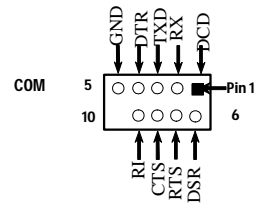
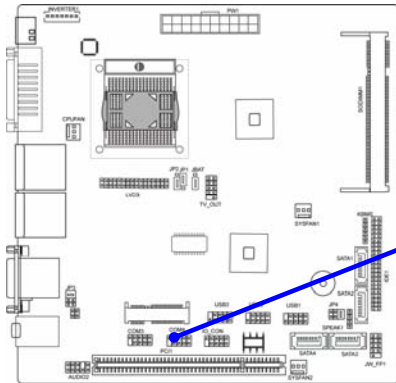

**COM Header**

**(10) GPIO Header (9-pin):**

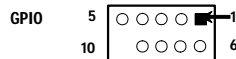
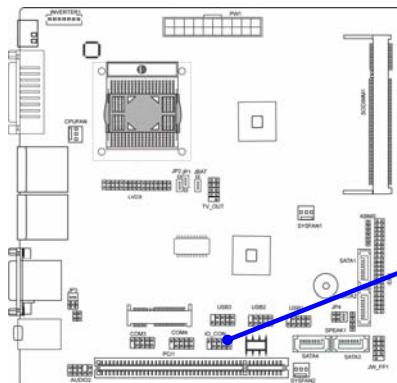

**GPIO Header**

PIN	Define	PIN	Define
1	GPIO_20	6	GPIO_26
2	GPIO_24	7	GPIO_23
3	GPIO_21	8	GPIO_27
4	GPIO_25	9	GND
5	GPIO_22	10	VCC

---

(11) **KBMS Header:**

The header is for PS/2 keyboard and PS/2 Mouse input devices.

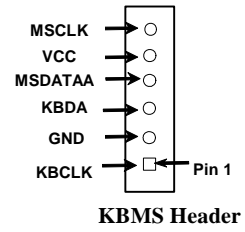
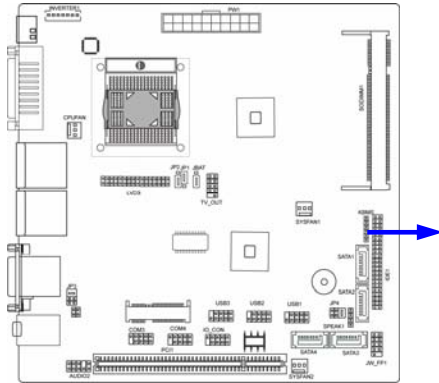

---

---

## Chapter 3

### Introducing BIOS

**Attention:** The BIOS options shown in this manual is for reference use only. We reserve the right to update the BIOS version without advance notice.

The BIOS is a program located on a Flash Memory on the motherboard. This program is a bridge between motherboard and operating system. When you start the computer, the BIOS program will gain control. The BIOS first operates an auto-diagnostic test called POST (power on self test) for all the necessary hardware, it detects the entire hardware device and configures the parameters of the hardware synchronization. Only when these tasks are completed done it gives up control of the computer to operating system (OS). Since the BIOS is the only channel for hardware and software to communicate, it is the key factor for system stability, and in ensuring that your system performance as its best.

In the BIOS Setup main menu of Figure 3-1, you can see several options. We will explain these options step by step in the following pages of this chapter, but let us first see a short description of the function keys you may use here:

- Press <Esc> to quit the BIOS Setup.
- Press ↑↓←→ (up, down, left, right) to choose, in the main menu, the option you want to confirm or to modify.
- Press <F10> when you have completed the setup of BIOS parameters to save these parameters and to exit the BIOS Setup menu.
- Press Page Up/Page Down or +/- keys when you want to modify the BIOS parameters for the active option.

---

---

## 3-1 Entering Setup

Power on the computer and by pressing <Del> immediately allows you to enter Setup.

If the message disappears before you respond and you still wish to enter Setup, restart the system to try again by turning it OFF then ON or pressing the “RESET” button on the system case. You may also restart by simultaneously pressing <Ctrl>, <Alt> and <Delete> keys. If you do not press the keys at the correct time and the system does not boot, an error message will be displayed and you will again be asked to

**Press <F1> to continue, or <Del> to enter Setup**

## 3-2 Getting Help

### Main Menu

The on-line description of the highlighted setup function is displayed at the bottom of the screen.

### Status Page Setup Menu/Option Page Setup Menu

Press F1 to pop up a small help window that describes the appropriate keys to use and the possible selections for the highlighted item. To exit the Help Window, press <Esc>.

## 3-3 The Main Menu

Once you enter Award® BIOS CMOS Setup Utility, the Main Menu (Figure 3-1) will appear on the screen. The Main Menu allows you to select from fourteen setup functions and two exit choices. Use arrow keys to select among the items and press <Enter> to accept or enter the sub-menu.



---

---

Phoenix - AwardBIOS CMOS Setup Utility

Standard CMOS Features	Load Fail-safe Defaults
Advanced BIOS Features	Load Optimized Defaults
Advanced Chipset Features	Set Supervisor Password
Integrated Peripherals	Set User Password
Power Management Setup	Save & Exit Setup
PnP/PCI Configurations	Exit Without Saving
PC Health Status	
Esc : Quit    F9 : Menu in BIOS    ↑↓→← : Select Item	
F10 : Save & Exit Setup	

Figure 3-1

### **Standard CMOS Features**

Use this Menu for basic system configurations.

### **Advanced BIOS Features**

Use this menu to set the Advanced Features available on your system.

### **Advanced Chipset Features**

Use this menu to change the values in the chipset registers and optimize your system's performance.

### **Integrated Peripherals**

Use this menu to specify your settings for integrated peripherals.

### **Power Management Setup**

Use this menu to specify your settings for power management.

### **Miscellaneous Control**

---

---

Use this menu to specify your settings for **Miscellaneous Control**.

**PC Health Status**

This entry shows your PC health status.

**Power User Overclock Settings**

Use this menu to specify your settings (frequency, Voltage) for overclocking demand

**CPU Thermal Throttling Setting**

The selection is set for activating the active CPU Thermal Protection by flexible CPU loading adjustment in the arrangement of temperature you defined.

**Load Optimized Defaults**

Use this menu to load the BIOS default values these are setting for optimal performances system operations for performance use.

**Password Settings**

This entry for setting Supervisor password and User password

**Save & Exit Setup**

Save CMOS value changes to CMOS and exit setup.

**Exit Without Saving**

Abandon all CMOS value changes and exit setup.

---

---

## 3-4 Advanced BIOS Features

Phoenix - AwardBIOS CMOS Setup Utility

### Advanced BIOS Features

CPU Feature	Press Enter	Item Help	
Hard Disk Boot Priority	Press Enter		
Virus Warning	Disabled	Menu Level >	
CPU L3 Cache	Enabled		
Quick power on self Test	Enabled		
First Boot Device	HARD DISK		
Second Boot Device	CDROM		
Third Boot Device	Disabled		
Boot other Device	Enabled		
Boot Up NumLock Status	On		
Typematic Rate Setting	Disabled		
Typematic Rate (Chars/Sec)	6		
Typematic Delay (Msec)	250		
Security Option	Setup		
APIC Mode	Enabled		
MPS Version Control For OS	1.4		
OS Select For DRAM > 64MB	Non-OS2		
Report No FDD For WIN 95	Yes		
Small Logo(EPA) Show	Disabled		
Summary Screen Show	Disabled		
↑↓→← Move Enter:Select +/-/PU/PD:Value F10:Save ESC:Exit F1:General Help F5:Previous Values F6:Optimized Defaults F7:Standard Defaults			

### Hard Disk Boot Priority

The selection is for you to choose the hard disk drives priorities to boot from.

### Virus Warning

The selection Allow you to choose the VIRUS Warning feature for IDE Hard Disk boot sector protection. If this function is enabled and someone attempt to write data into this area, BIOS will show a warning message on screen and alarm beep.

---

---

**Disabled** (default) No warning message to appear when anything attempts to access the boot sector or hard disk partition table.

**Enabled** Activates automatically when the system boots up causing a warning message to appear when anything attempts to access the boot sector of hard disk partition table.

### **CPU Internal Cache**

The default value is Enabled.

**Enabled** (default) Enable cache

**Disabled** Disable cache

*Note: The internal cache is built in the processor.*

### **External Cache**

Choose Enabled or Disabled. This option enables the Level 2 cache memory.

### **Quick Power On Self-Test**

This category speeds up Power On Self Test (POST) after you power on the computer. If this is set to Enabled, BIOS will shorten or skip some check items during POST.

**Enabled** (default) Enable quick POST

**Disabled** Normal POST

### **First/Second/Third Boot Device**

The BIOS attempts to load the operating system from the devices in the sequence selected in these items. The settings are Floppy, LS/ZIP, HDD-0/HDD-1/HDD-3, SCSI, CDROM, LAD and Disabled.

### **Boot Up Floppy Seek**

During POST, BIOS will determine if the floppy disk drive installed is 40 or 80 tracks. 360K type is 40 tracks while 760K; 1.2M and 1.44M are all 80 tracks.

### **Boot Up NumLock Status**

The default value is on.

**On** (default) Keypad is numeric keys.

**Off** Keypad is arrow keys.

### **Typematic Rate Setting**

Keystrokes repeat at a rate determined by the keyboard controller. When enabled, the typematic rate and typematic delay can be selected. The settings are: Enabled/Disabled.

---

---

### **Typematic Rate (Chars/Sec)**

Set the number of times a second to repeat a keystroke when you hold the key down. The settings are: 6, 8, 10, 12, 15, 20, 24, and 30.

### **Typematic Delay (Msec)**

Sets the delay time after the key is held down before beginning to repeat the keystroke. The settings are 250, 500, 750, and 1000.

### **Security Option**

This category allows you to limit access to the system and Setup, or just to Setup.

- |                        |   |
|------------------------|---|
| <b>System</b>          | The system will not boot and access to Setup will be denied if the correct password is not entered at the prompt. |
| <b>Setup (default)</b> | The system will boot, but access to Setup will be denied if the correct password is not entered prompt.           |

### **HDD S.M.A.R.T Capability**

This option allow you to enable the HDD S.M.A.R.T Capability (Self-Monitoring, Analysis and Reporting Technology) . You can choose from Enabled and Disabled.

### **MPS Version Control For OS 1.4**

This option is only valid for multiprocessor motherboards as it specifies the version of the Multiprocessor Specification (MPS) that the motherboard will use.

### **OS Select For DRAM > 64MB**

Allows OS2<sup>®</sup> to be used with >64MB or DRAM. Settings are Non-OS/2 (default) and OS2. Set to OS/2 if using more than 64MB and running OS/2<sup>®</sup>.

---

---

## 3-4-1 CPU Feture

Phoenix - AwardBIOS CMOS Setup Utility

### CPU Features

C1E Function	Auto	Item Help
CPU C State Capability	Disabled	Menu Level >
Execute Disable Bit	Enabled	
Core Multi-Processing	Enabled	
↑↓←→ Move Enter:Select +/-/PU/PD:Value F10:Save ESC:Exit F1:General Help F5:Previous Values F6:Optimized Defaults F7:Standard Defaults		

## 3-5 Intergrated peripherals

Phoenix - AwardBIOS CMOS Setup Utility

### Intergrated peripheral

SIO Device	Press Enter	Item Help
Onchip IDE Device	Press Enter	Menu Level >>
Onboard Device	Press Enter	
Intel Dis Feature	Press Enter	
USB Device Setting	Press Enter	
RS422/485 Auto Flow Cntrl	Disabled	
Power On By Mouse	Disabled	
Power On By Keyboard	Disabled	
Watch Dog set	Disabled	
Watch Dog Timer	10	
PWRON After PWR-Fail	Off	
↑↓←→ Move Enter:Select +/-/PU/PD:Value F10:Save ESC:Exit F1:General Help F5:Previous Values F6:Optimized Defaults F7:Standard Defaults		

---

---

## 3-5-1 Intel DTS Feature

### Phoenix - AwardBIOS CMOS Setup Utility

#### Intel DTS Feature

Intel DTS Function	Enabled	Item Help
DTS Active temperature	55°C	Menu Level >
Passive Cooling Trip Point	95°C	
Passive TC1 Value	2	
Passive TC2 Value	0	
Passive TSP Value	10	
↑↓←→ Move Enter:Select +/-/PU/PD:Value F10:Save ESC:Exit F1:General Help F5:Previous Values F6:Optimized Defaults F7:Standard Defaults		

#### **DTS Active Temperature:**

This value controls the temperature of the ACPI Active Trip Point- the point in which the os will turn the CPU on.

NOTE: If the DTS is enabled, only values below 97°C are valid.

#### **Passive Cooling Trip Point:**

This value controls the temperature of the ACPI Active Trip Point- the point in which the os will begin throttling the CPU.

NOTE: If the DTS is enabled, only values below 97°C are valid.

#### **Passive TC1 value:**

This value sets the TC1 value for the ACPI passive cooling Formula.

#### **Passive TSP Value:**

This item sets the TSP value for the ACPI Passive cooling Formula. It represents in tenths of a second how often the os will read the temperature when Passive Cooling is Enabled.

#### **Critical Trip Point:**

---

---

This value controls the temperature of the ACPI critical Trip point—the point in which the OS will shut the system off.

NOTES: (1) 100°C is POP for all the Intel CPUs. (2) If value is >100°C and DTS is enabled, the Out-of-spec Bit will be used. (3) The value will be set to 127 after ACPI initialization.

### **Watchdog Timer Select**

This item is used to activate the watchdog function. The optional settings are: Enabled; Disabled. When set it as Enabled user can choose configuration figures in sub items.

### **Watchdog Timer Value**

This item is only activated when Watchdog Timer Select is set as Enabled and users can set a value from the range of 0~255

**\*Note: User needs an additional Watchdog Programming Reference Code to make use of this BIOS function. Detailed procedures please download from our website if necessary.**



---

---

## 3-6 PC Health Status

This section shows the Status of you CPU, Fan, and Warning for overall system status. This is only available if there is Hardware Monitor onboard.

### Phoenix - AwardBIOS CMOS Setup Utility

#### PC Health Status

CPU FAN Configuration	Press Enter	Item Help
SYS FAN1 Configuration	Press Enter	
SYS FAN2 Configuration	Press Enter	Menu Level >
Shutdown Temperature	Disabled	
VCC 3.3	3.34V	
VSB	3.36V	
Voltage Battery	3.36V	
CPU Temp	42	
SYS Temp	47	
CPU Fan Speed	6482RPM	
SYS1 Fan Speed	0RPM	
SYS2 Fan Speed	0RPM	
↑↓←→ Move Enter:Select +/-/PU/PD:Value F10:Save ESC:Exit F1:General Help F5:Previous Values F6:Optimized Defaults F7:Standard Defaults		

### CPU FAN Configurations

#### CPU Full-Speed Temp

This item allows you setting the FAN works in full speed when the temperature over the value which out set. If the temperature below the value but over the Idle Temperature, the FAN will works over 60% of full speed, and the higher temperature will gain higher FAN speed, after over the temperature which this item setting, the FAN works in full speed.

#### CPU Idle Temp

This item allows you setting the FAN works in 60% of full speed, when the temperature lower than the temperature which you setting.

---

---

## 3-7 Advanced Chipset Features

The Advanced Chipset Features Setup option is used to change the values of the chipset registers. These registers control most of the system options in the computer.

### Phoenix - AwardBIOS CMOS Setup Utility

#### Advanced Chipset Features

System BIOS Cacheable	Enabled	M
Memory Hole At 15M-16M	Disabled	
Vt-d	Disabled	
VGA Setting		
On-chip Frame Buffer Size	32Mb	Menu Level >
DVMT Mode	Enabled	
Total GFX Memory	256MB	
PAVP Mode	PAVP-List	
VGA Boot Device Setting		
Boot Display	VBIOS Default	
Panel Scaling	Auto	
Panel Type	VBIOS Default	
TV1 Standard Type	VBIOS Default	
LVDS Switch	Default	
CPU Spread Support	Disabled	
Spread Mode	Down Spread	

↑↓→← Move Enter: Select +/-/PU/PD: Value F10:Save ESC: Exit F1:General Help  
F5:Previous Values F6:Optimized Defaults F7:Standard Defaults

### System BIOS Cacheable

Selecting Enabled allows caching of the system BIOS ROM at F0000h-FFFFFh, resulting in better system performance. However, if any program writes to this memory area, a system error may result. The settings are: Enabled and Disabled.

### Total GFX Memory:

For WinXP, the MAX value is base on system memory size 512MB for 1GB DRAM, 768MB for 1.5GB to 2 GB, 1GB for above 2GB.

---

---

## Boot Display:

Select the video Device that will be activated during POST.

## 3-8 Power Management Setup

The Power Management Setup allows you to configure your system to most effectively save energy saving while operating in a manner consistent with your own style of computer use.

### Phoenix - AwardBIOS CMOS Setup Utility

#### Power Management Setup

PCI Express PM Function	Press Enter	Item Help
ACPI Suspend Type	S1(pos)	
Run VGABIOS if S3 Resume	Auto	Menu Level >
Power Management	USER Define	
Video off Method	DPMS	
Video off Suspend	Yes	
Suspend Type	Stop Grant	
MODEN USE IRQ	3	
Suspend Mode	Disabled	
Soft-off by PWR-BTTN	Instant-off	
Wake-up by PCI card	Disabled	
Power on by ring	Eabled	
USB KB Wake up from S3(S4)	Disabled	
Resume by Alarm	Disabled	
Date (of Month) Alarm	0	
Time (hh:mm:ss)Alarm	0:0:0	
HPET Support	Enabled	
HPET Mode	32-bit mde	
↑↓←→ Move Enter:Select +/-/PU/PD:Value F10:Save ESC:Exit F1:General Help F5:Previous Values F6:Optimized Defaults F7:Standard Defaults		

### ACPI Function

This item allows you to Enabled/Disabled the Advanced Configuration and Power Management (ACPI). The settings are Enabled and Disabled.

### Video Off Method

This determines the manner in which the monitor is blanked.

---

---

**DPMS (default)** Initial display power management signaling.

**Blank Screen** This option only writes blanks to the video buffer.

**V/H SYNC+Blank** This selection will cause the system to turn off the vertical and horizontal synchronization ports and write blanks to the video buffer.

**MODEM Use IRQ**

If you want an incoming call on a modem to automatically resume the system from a power-saving mode, use this item to specify the interrupt request line (IRQ) that is used by the modem. You might have to connect the fax/modem to the motherboard Wake On Modem connector for this feature to work.

**Soft-Off by PWRBTN**

Under ACPI (Advanced Configuration and Power management Interface) you can create a software power down. In a software power down, the system can be resumed by Wake up Alarms. This item lets you install a software power down that is controlled by the power Button on your system. If the item is set to Instant-Off, then the power button causes a software power down. If the item is set to Delay 4 Sec, then you have to hold the power button down for four seconds to cause a software power down.

---

---

## 3-9 PnP/PCI Configuration

Phoenix - AwardBIOS CMOS Setup Utility

### Pnp/PCI Configuration

Init Display First	PCI Slot	Item Help
Reset Configuration Data	Disabled	
Recourse Configuration By	Auto(ESD)	Menu Level >
IRQ Recourses	Press Enter	
PCI/VGA Palette Snoop	Disabled	
INT pin 1 Assignment	Auto	
INT pin 2 Assignment	Auto	
INT pin 3 Assignment	Auto	
INT pin 4 Assignment	Auto	
INT pin 5 Assignment	Auto	
INT pin 6 Assignment	Auto	
INT pin 7 Assignment	Auto	
INT pin 8 Assignment	Auto	
PCI Express relative items		
Maximum Payload size	128	
↑↓←→ Move Enter:Select +/-/PU/PD:Value F10:Save ESC:Exit F1:General Help F5:Previous Values F6:Optimized Defaults F7:Standard Defaults		

